

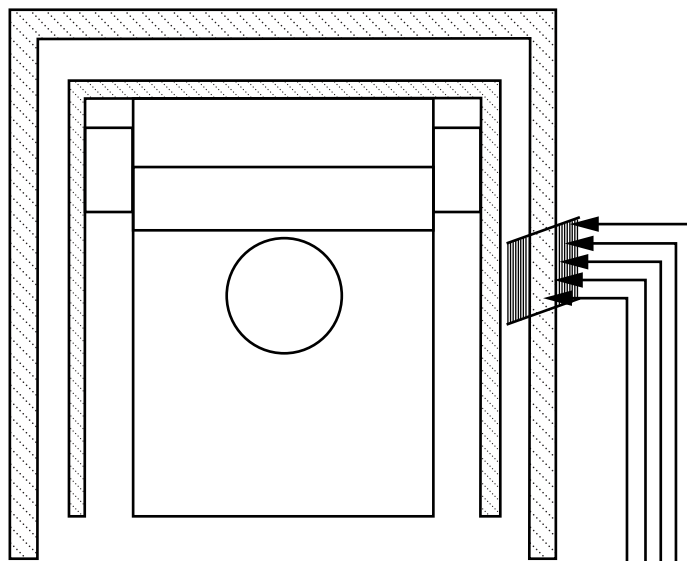

VICTORY 4R IND PINCH SPEAR W/ FLUSH BOTTOM SPECIFICATIONS

Pickets: 1" x 1" x 14GA or 16GA
Rails: 1 3/4" x 1 3/4" x 12GA or 14GA
Posts: 2.5" or 3"
Heights: 3', 4', 5', 6', 7' and 8'

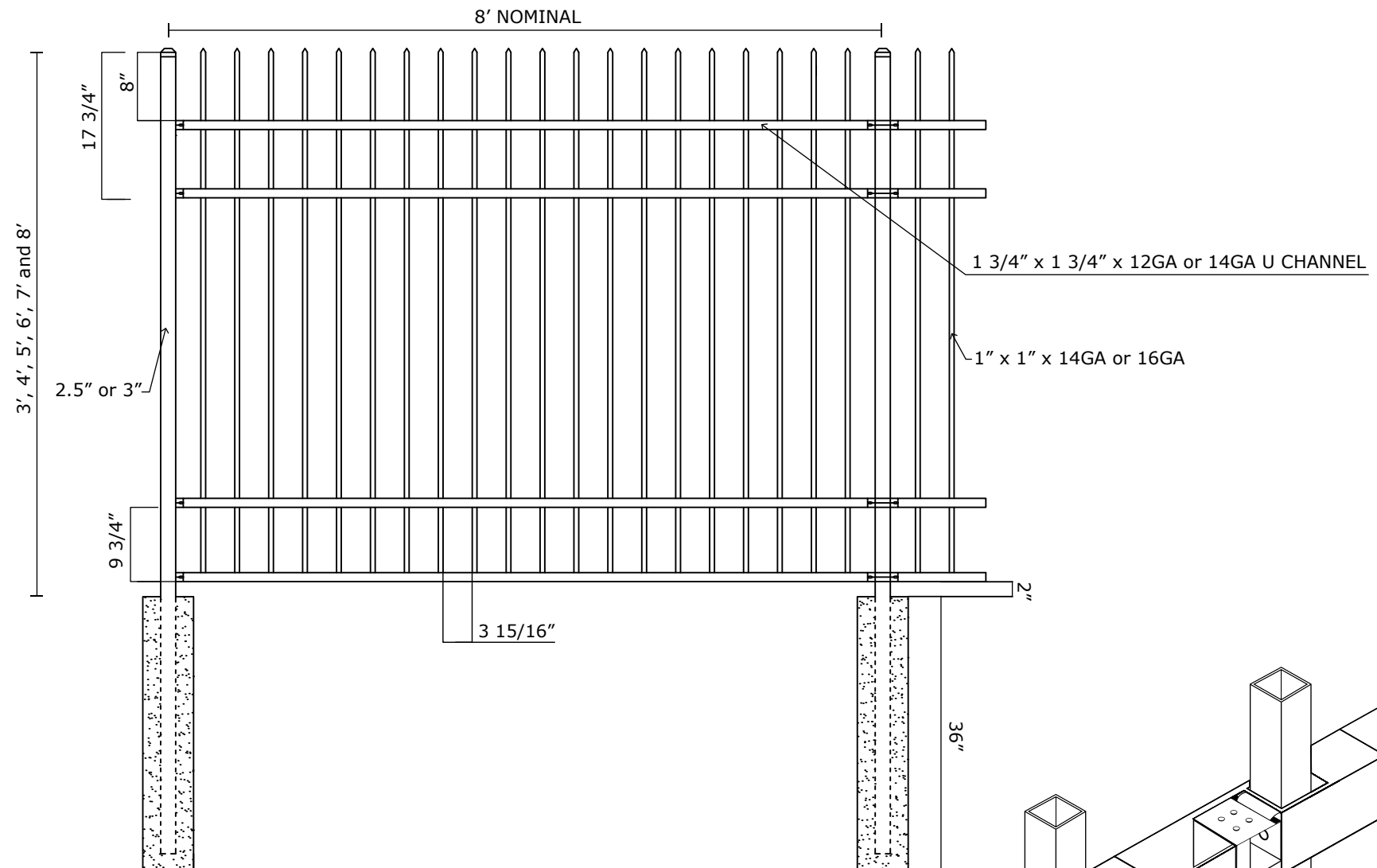

350MPA 4500 PSI STEEL
G60 HOT DIP GALVANIZATION
ZINC PHOSPHATE COAT + SAND BLAST COAT
EPOXY PRIMER
VICTORY TOP COAT (20 YEAR WARRANTY)

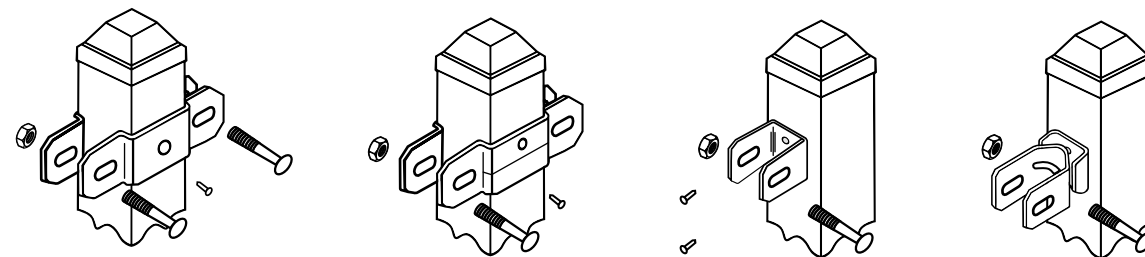

VANTAGE FENCE
VICTORY RESIDENTIAL PANELS
www.vantagefence.com

4R VIC IND PINCH SPEAR W/ FLUSH BOTTOM