



VICTORY 4R IND PINCH SPEAR W/ EXTENDED PICKET SPECIFICATIONS

Pickets: 1" x 1" x 14GA or 16GA

Rails: 1 3/4" x 1 3/4" x 12GA or 14GA

Posts: 2.5" or 3"

Heights: 3', 4', 5', 6', 7' and 8'

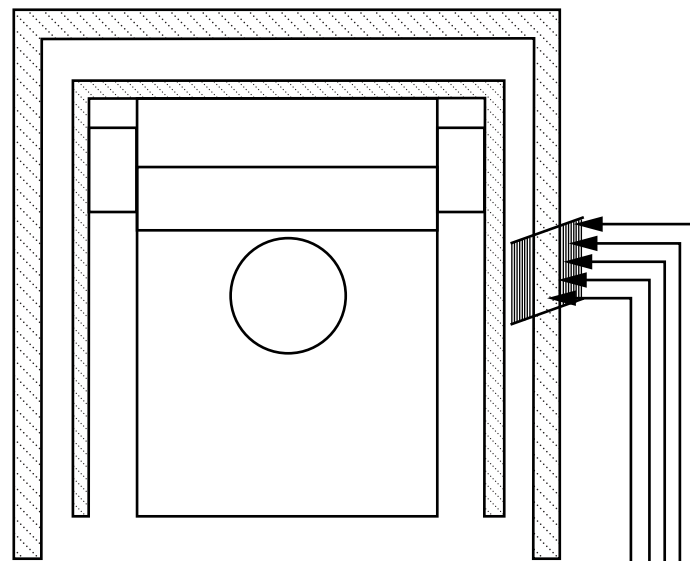
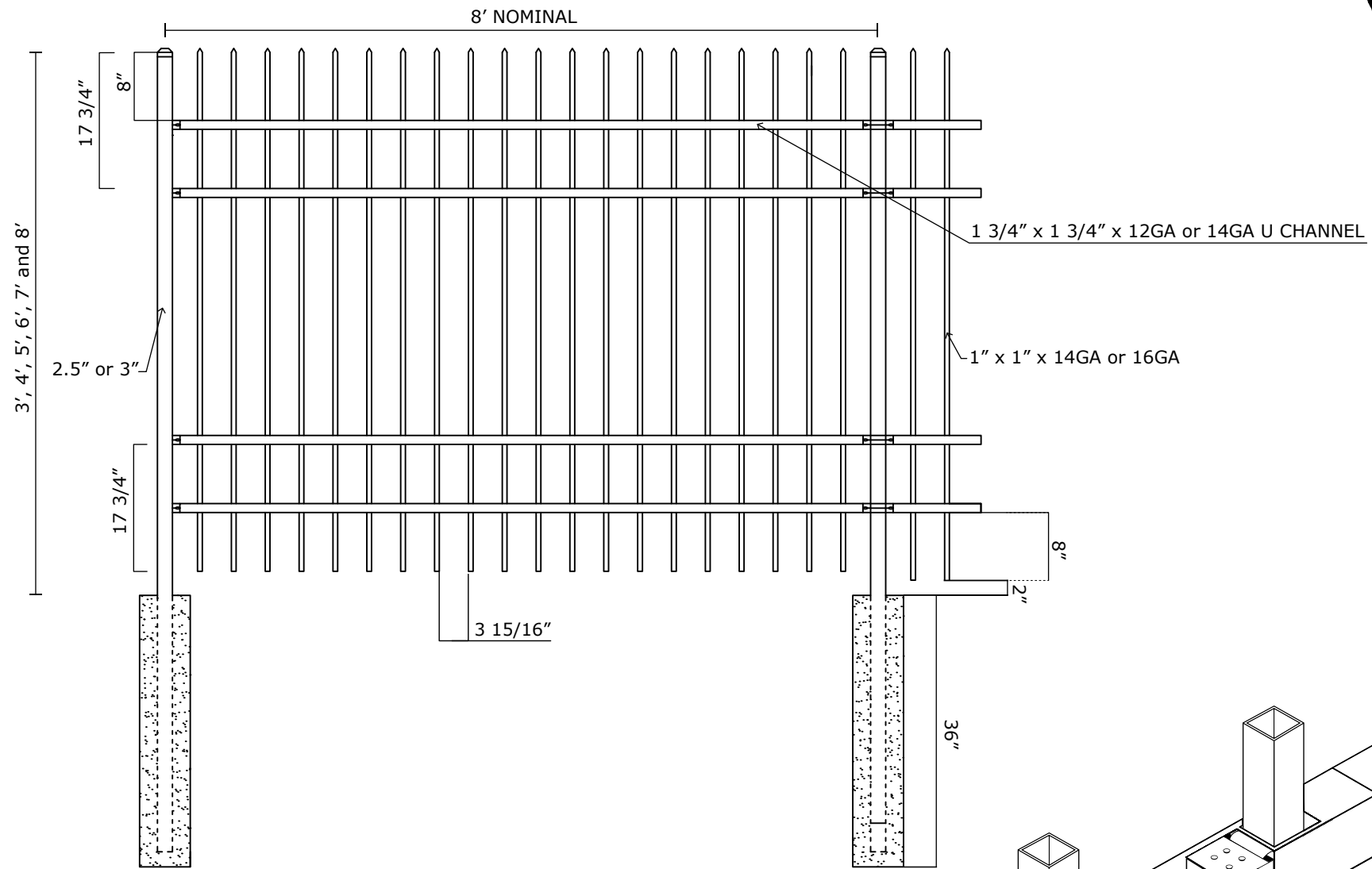

- 350MPA 4500 PSI STEEL
- G60 HOT DIP GALVANIZATION
- ZINC PHOSPHATE COAT + SAND BLAST COAT
- EPOXY PRIMER
- VICTORY TOP COAT (20 YEAR WARRANTY)

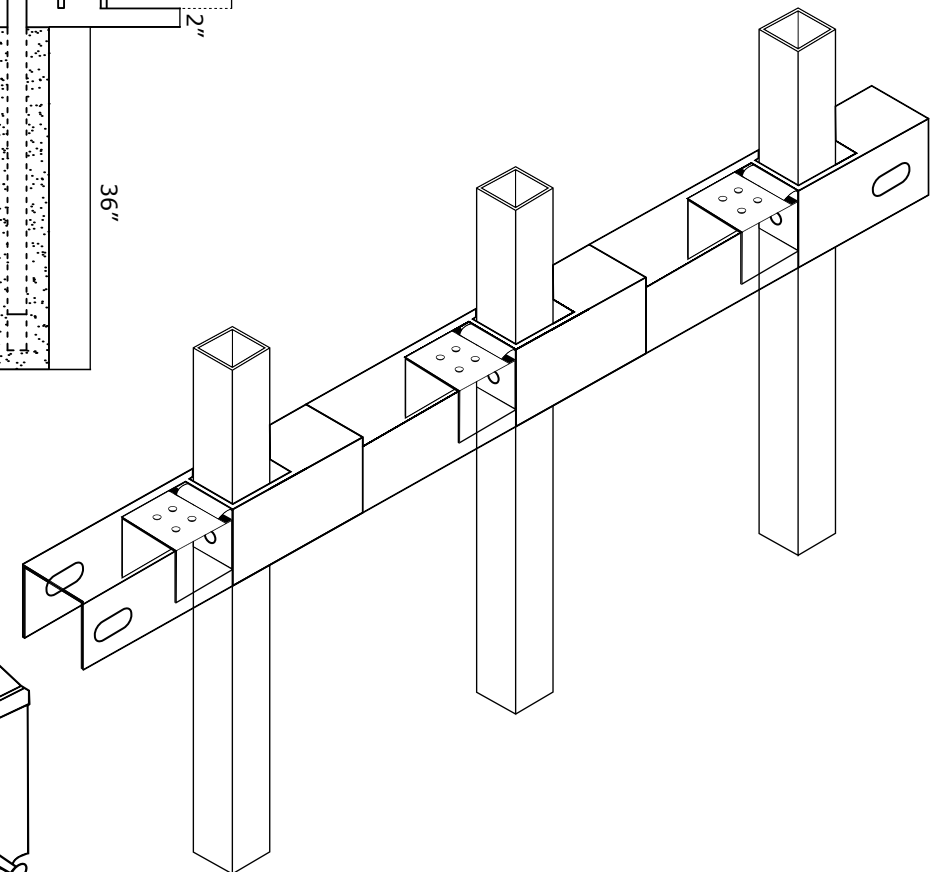
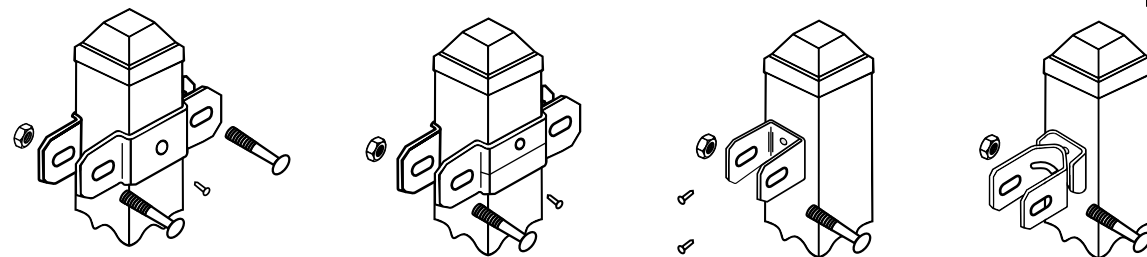

VANTAGE FENCE
VICTORY RESIDENTIAL PANELS
www.vantagefence.com

4R VIC IND PINCH SPEAR W/ EXTENDED PICKET